

Acer Projector
K10 User's Guide

Copyright © 2008. Acer Incorporated.
All Rights Reserved.

Acer Projector K10 User's Guide
Original Issue: 12/2008

Changes may be made periodically to the information in this publication without obligation to notify any person of such revisions or changes. Such changes will be incorporated in new editions of this manual or supplementary documents and publications. This company makes no representations or warranties, either expressed or implied, with respect to the contents hereof and specifically disclaims the implied warranties of merchantability or fitness for a particular purpose.

Record the model number, serial number, purchase date and place of purchase information in the space provided below. The serial number and model number are recorded on the label affixed to your computer. All correspondence concerning your unit should include the serial number, model number and purchase information.

No part of this publication may be reproduced, stored in a retrieval system, or transmitted, in any form or by any means, electronically, mechanically, by photocopy, recording or otherwise, without the prior written permission of Acer Incorporated.

Acer Projector K10

Model number: _____

Serial number: _____

Date of purchase: _____

Place of purchase: _____

Acer and the Acer logo are registered trademarks of Acer Incorporated. Other companies' product names or trademarks are used herein for identification purposes only and belong to their respective companies.

Information for your safety and comfort

Read these instructions carefully. Keep this document for future reference. Follow all warnings and instructions marked on the product.

Turning the product off before cleaning

Unplug this product from the wall outlet before cleaning. Do not use liquid cleaners or aerosol cleaners. Use a damp cloth for cleaning.

Caution for plug as disconnecting device

Observe the following guidelines when connecting and disconnecting power to the external power supply unit:

- Install the power supply unit before connecting the power cord to the AC power outlet.
- Unplug the power cord before removing the power supply unit from the computer.
- If the system has multiple sources of power, disconnect power from the system by unplugging all power cords from the power supplies.

Caution for Accessibility

Be sure that the power outlet you plug the power cord into is easily accessible and located as close to the equipment operator as possible. When you need to disconnect power to the equipment, be sure to unplug the power cord from the electrical outlet.



Warnings!

- Do not use this product near water.
- Do not place this product on an unstable cart, stand or table. If the product falls, it could be seriously damaged.
- Slots and openings are provided for ventilation to ensure reliable operation of the product and to protect it from overheating. These openings must not be blocked or covered. The openings should never be blocked by placing the product on a bed, sofa, rug or other similar surface.

This product should never be placed near or over a radiator or heat register, or in a built-in installation unless proper ventilation is provided.

- Never push objects of any kind into this product through cabinet slots as they may touch dangerous voltage points or short-out parts that could result in a fire or electric shock. Never spill liquid of any kind onto or into

the product.

- To avoid damage of internal components and to prevent battery leakage, do not place the product on a vibrating surface.
- Never use it under sporting, exercising, or any vibrating environment which will probably cause unexpected short current or damage rotor devices, lamp.

Using electrical power

- This product should be operated from the type of power indicated on the marking label. If you are not sure of the type of power available, consult your dealer or local power company.
- Do not allow anything to rest on the power cord. Do not locate this product where people will walk on the cord.
- If an extension cord is used with this product, make sure that the total ampere rating of the equipment plugged into the extension cord does not exceed the extension cord ampere rating. Also, make sure that the total rating of all products plugged into the wall outlet does not exceed the fuse rating.
- Do not overload a power outlet, strip or receptacle by plugging in too many devices. The overall system load must not exceed 80% of the branch circuit rating. If power strips are used, the load should not exceed 80% of the power strip's input rating.
- This product's power cord is equipped with a three-wire grounded plug. The plug only fits in a grounded power outlet. Make sure the power outlet is properly grounded before inserting the power cord plug. Do not insert the plug into a non-grounded power outlet. Contact your electrician for details.



.....
Warning! The grounding pin is a safety feature. Using a power outlet that is not properly grounded may result in electric shock and/or injury.



.....
Note: The grounding pin also provides good protection from unexpected noise produced by other nearby electrical devices that may interfere with the performance of this product.

- Use the product only with the supplied power supply cord set.

Product servicing

Do not attempt to service this product yourself, as opening or removing covers may expose you to dangerous voltage points or other risks. Refer all servicing to qualified service personnel.

Unplug this product from the wall outlet and refer servicing to qualified service personnel when:

- the power cord or plug is damaged, cut or frayed
- liquid was spilled into the product
- the product was exposed to rain or water
- the product has been dropped or the case has been damaged
- the product exhibits a distinct change in performance, indicating a need for service
- the product does not operate normally after following the operating instructions



.....

Note: Adjust only those controls that are covered by the operating instructions, since improper adjustment of other controls may result in damage and will often require extensive work by a qualified technician to restore the product to normal condition.



.....

Warning! For safety reasons, do not use non-compliant parts when adding or changing components. Consult your reseller for purchase options.

Your device and its enhancements may contain small parts. Keep them out of the reach of small children.

Additional safety information

- Do not look into the projector's lens when the lamp is on. The bright may hurt your eyes.
- Turn on the projector first and then signal sources.
- Do not place the product in following environments:
 - Space that is poorly ventilated or confined. At least 10cm clearance from walls and free flow of air around the projector is necessary.
 - Locations where temperatures may become excessively high, such as inside of a car with all windows rolled up.
 - Locations where excessive humidity, dust, or cigarette smoke may contaminate optical components, shortening the life span and darkening the image.
 - Locations near fire alarms.
 - Locations with an ambient temperature above 35 °C/95 °F.
 - Locations where the altitudes are higher than 10000 feet.
- Unplug immediately if there is something wrong with your projector. Do not operate if smoke, strange noise or odor comes out of your projector. It

might cause fire or electric shock. In this case, unplug immediately and contact your dealer.

- Do not keep using this projector if it is broken or you have dropped it. In this case, contact your dealer for inspection.
- Do not face the projector lens to the sun. It can lead to fire.
- When switching the projector off, please ensure the projector completes its cooling cycle before disconnecting power.
- Do not touch air outlet grille and bottom plate which becomes hot.
- Do not look into the air outlet grille when projector is operating. It may hurt your eyes.
- Do not block the projector lens with any object when the projector is under operation as this could cause the object to become heated and deformed or even cause a fire.
- Do not attempt to disassemble this projector. There are dangerous high voltages inside which may hurt you. Refer servicing only to suitable qualified professional service personnel.
- Do not stand the projector on end vertically. It may cause the projector to fall over, causing injury or damage.

Operating environment for using wireless (optional)



.....

Warning! For safety reasons, turn off all wireless or radio transmitting devices when using your machine under the following conditions. These devices may include, but are not limited to: wireless LAN (WLAN), Bluetooth and/or 3G.

Remember to follow any special regulations in force in any area, and always switch off your device when its use is prohibited or when it may cause interference or danger. Use the device only in its normal operating positions. This device meets RF exposure guidelines when used normally, and it and its antenna are positioned at least 1.5 centimeters (5/8 inches) away from your body. It should not contain metal and you should position the device the above-stated distance from your body.

To successfully transmit data files or messages, this device requires a good quality connection to the network. In some cases, transmission of data files or messages may be delayed until such a connection is available.

Ensure that the above separation distance instructions are followed until the transmission is completed.

Parts of the device are magnetic. Metallic materials may be attracted to the device, and persons with hearing aids should not hold the device to the ear with the hearing aid. Do not place credit cards or other magnetic storage media near the device, because information stored on them may be erased.

Medical devices

Operation of any radio transmitting equipment, including wireless phones, may interfere with the functionality of inadequately protected medical devices. Consult a physician or the manufacturer of the medical device to determine if they are adequately shielded from external RF energy or if you have any questions. Switch off your device in health care facilities when any regulations posted in these areas instruct you to do so. Hospitals or health care facilities may be using equipment that could be sensitive to external RF transmissions.

Pacemakers. Pacemaker manufacturers recommend that a minimum separation of 15.3 centimeters (6 inches) be maintained between wireless devices and a pacemaker to avoid potential interference with the pacemaker. These recommendations are consistent with the independent research by and recommendations of Wireless Technology Research. Persons with pacemakers should do the following:

- Always keep the device more than 15.3 centimeters (6 inches) from the pacemaker.
- Not carry the device near your pacemaker when the device is switched on. If you suspect interference, switch off your device, and move it.

Hearing aids. Some digital wireless devices may interfere with some hearing aids. If interference occurs, consult your service provider.

Vehicles

RF signals may affect improperly installed or inadequately shielded electronic systems in motor vehicles such as electronic fuel injection systems, electronic antiskid (antilock) braking systems, electronic speed control systems, and air bag systems. For more information, check with the manufacturer, or its representative, of your vehicle or any equipment that has been added. Only qualified personnel should service the device, or install the device in a vehicle. Faulty installation or service may be dangerous and may invalidate any warranty that may apply to the device. Check regularly that all wireless equipment in your vehicle is mounted and operating properly. Do not store or carry flammable liquids, gases, or explosive materials in the same compartment as the device, its parts, or enhancements. For vehicles equipped with an air bag, remember that air bags inflate with great force. Do not place objects, including installed or portable wireless equipment in the area over the air bag or in the air bag deployment area. If in-vehicle wireless equipment is improperly installed, and the air bag inflates, serious injury could result.

Using your device while flying in aircraft is prohibited. Switch off your device before boarding an aircraft. The use of wireless teledevices in an aircraft may be dangerous to the operation of the aircraft, disrupt the wireless telephone network, and may be illegal.

Potentially explosive environments

Switch off your device when in any area with a potentially explosive atmosphere and obey all signs and instructions. Potentially explosive

atmospheres include areas where you would normally be advised to turn off your vehicle engine. Sparks in such areas could cause an explosion or fire resulting in bodily injury or even death. Switch off the device at refueling points such as near gas pumps at service stations. Observe restrictions on the use of radio equipment in fuel depots, storage, and distribution areas; chemical plants; or where blasting operations are in progress. Areas with a potentially explosive atmosphere are often, but not always, clearly marked. They include below deck on boats, chemical transfer or storage facilities, vehicles using liquefied petroleum gas (such as propane or butane), and areas where the air contains chemicals or particles such as grain, dust or metal powders.

Hearing Protection

To protect your hearing, follow these instructions.

- Increase the volume gradually until you can hear clearly and comfortably.
- Do not increase the volume level after your ears have adjusted.
- Do not listen to music at high volumes for extended periods.
- Do not increase the volume to block out noisy surroundings.
- Decrease the volume if you can't hear people speaking near you.

Disposal instructions

Do not throw this electronic device into the trash when discarding. To minimize pollution and ensure utmost protection of the global environment, please recycle. For more information on the Waste from Electrical and Electronics Equipment (WEEE) regulations, visit <http://www.acer-group.com/public/Sustainability/sustainability01.htm>.



First things first

Usage Notes

Do:

- Turn off the product before cleaning.
- Use a soft cloth moistened with mild detergent to clean the projector housing.
- Disconnect the power plug from AC outlet if the product is not being used for a long period of time.

Don't:

- Block the slots and openings on the unit provided for ventilation.
- Use abrasive cleaners, waxes or solvents to clean the unit.
- Use under the following conditions:
 - In extremely hot, cold or humid environments.
 - In areas susceptible to excessive dust and dirt.
 - Near any appliance that generates a strong magnetic field.
 - Place in direct sunlight.

Precautions

Follow all warnings, precautions and maintenance as recommended in this user's guide to maximize the life of your unit.



.....
Warning:

- Do not look into the projector's lens when the lamp is on. The bright light may hurt your eyes.
- To reduce the risk of fire or electric shock, do not expose this product to rain or moisture.
- Please do not open or disassemble the product as this may cause electric shock.
- When switching the projector off, please ensure the projector completes its cooling cycle before disconnecting power.
- Turn on the projector first and then the signal sources.

Information for your safety and comfort	iii
First things first	ix
Usage Notes	ix
Precautions	ix
Introduction	1
Product Features	1
Contents	2
Projector Overview	3
Getting Started	5
Connecting the Projector	5
Turning the Projector On/Off	6
Adjusting the Projected Image	8
User Controls	11
Onscreen Display (OSD) Menus	11
Color Setting	12
Image Setting	13
Management Setting	15
Language Setting	15
Appendices	16
Troubleshooting	16
LED & Alarm Definition Listing	19
Specifications	20
Compatibility Modes	21
Regulations and Safety Notices	23

Contents

Introduction

Product Features

This product is a single-chip DLP® projector. Outstanding features include:

- DLP® technology
- 858 x 600 SVGA resolution
4:3 / 16:9 aspect ratio supported
- NTSC/PAL/SECAM compatible and HDTV (480i/p, 576i/p, 720p, 1080i) supported
- Compact size projector facilitates business purposes and home entertainment.
- Advanced digital keystone correction delivers optimum presentations
- Multi-language onscreen display (OSD) menus
- Microsoft® Windows® 2000, XP, Vista OS compliant

Contents

This projector comes with all the items shown below. Check to make sure your unit is complete. Contact your dealer immediately if anything is missing.

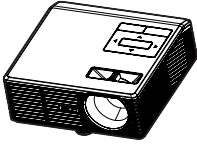

Projector

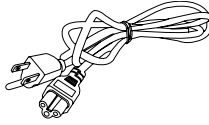

Power cord



VGA cable



Composite video cable

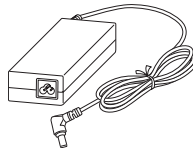

AC adapter

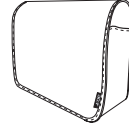

Carrying case



Quick start guide



User's Guide

Projector Overview

Projector Outlook

Front / upper side

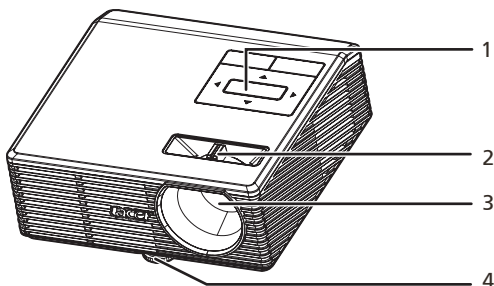

#	Description	#	Description
1	Control panel	3	Projection lens
2	Focus ring	4	Elevator foot



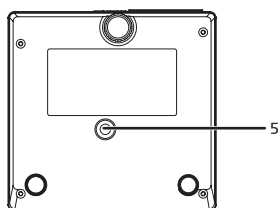
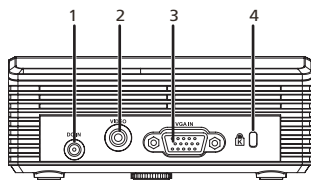

Rear side

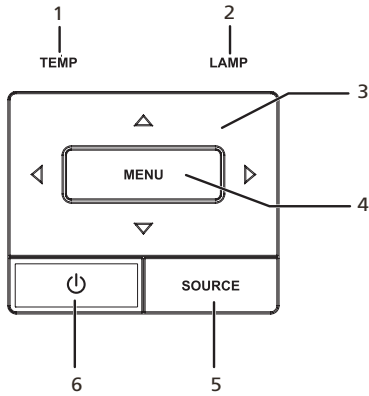

#	Description	#	Description
1	DC IN connector	4	Kensington lock port
2	Composite video input connector	5	Tripod socket
3	PC analog signal/HDTV/Component video input connector		

Control Panel



#	Function	Description
1	TEMP	Temp Indicator LED
2	LAMP	Lamp Indicator LED
3	Four directional select keys	Use     to select items or make adjustments to your selection.
4	MENU	<ul style="list-style-type: none"> Press "MENU" to launch the onscreen display (OSD) menu, back to the previous step for the OSD menu operation or exit the OSD menu. Confirm your selection of items.
5	SOURCE	Press " SOURCE " to choose RGB, Component, S-Video, Composite, DVI, HDTV and HDMI sources.
6	POWER	See the contents in " Turning the Projector On/Off " section.

Getting Started

Connecting the Projector

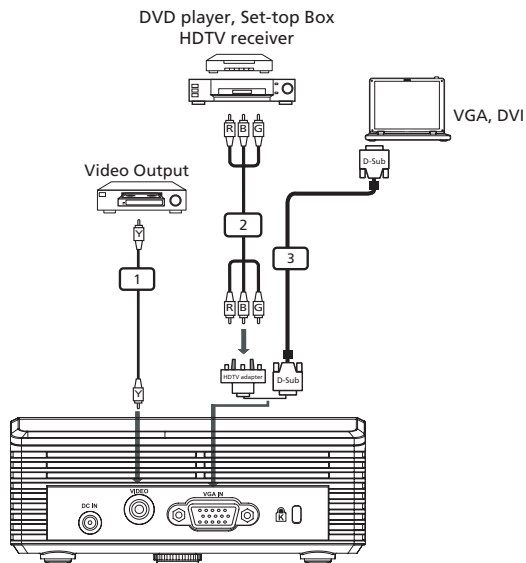

#	Description
1	Composite video cable
2	VGA to component/HDTV adapter
3	VGA cable



Note: To ensure the projector works well with your computer, please make sure the timing of the display mode is compatible with the projector.

Turning the Projector On/Off

Turning On the Projector

- 1 Ensure that the AC adapter, power cord and signal cable are securely connected. The Power LED will flash red.
- 2 Turn on the lamp by pressing "**Power**" button on the control panel, and the Power LED will turn blue.
- 3 Turn on your source (computer, notebook, video player ,etc.). The projector will detect your source automatically.
 - If the screen displays "Lock" & "Source" icons, it means the projector locks on this source type and there is no such type of input signal found.
 - If the screen displays "No Signal", please make sure the signal cables are securely connected.
 - If you connect multiple sources at the same time, using the "**Source**" button on control panel to switch between inputs.

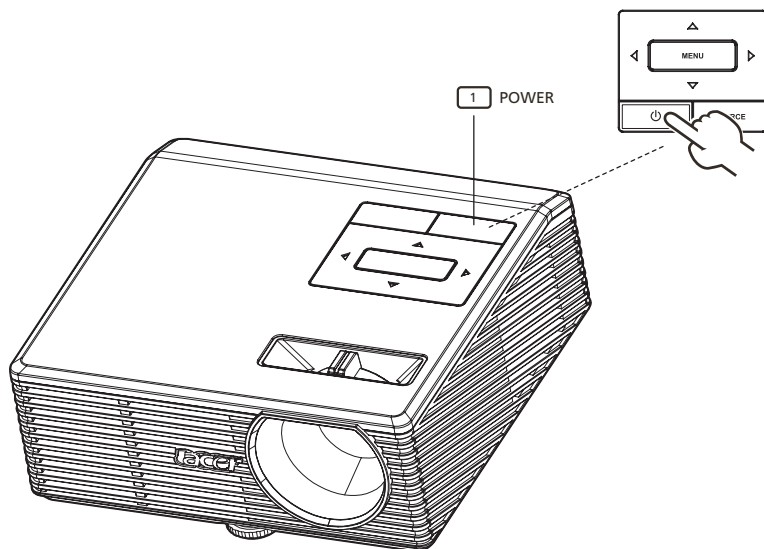

Turning Off the Projector

- 1 To turn off the projector press the "**Power**" button twice. The message below will display onscreen for 5 seconds.
"**Please press power button again to complete the shutdown process.**"
- 2 Immediately after powering off, the Power indicator LED will flash RED rapidly and the fan(s) will continue to operate for about 20 seconds. This is to ensure that the system cools correctly.
- 3 Once the system has finished cooling, the "**Power**" indicator LED will turn solid RED which means the projector enter standby mode.
- 4 It is now safe to unplug the power cord.



.....

Warning: Do not turn on the projector immediately after powering off.



.....

Warning indicators:

- If the projector automatically shuts down and the **TEMP** indicator turns solid RED, this indicates that the projector has overheated. The message below will display onscreen if this is about to happen:
"**Projector Overheated. Lamp will automatically turn off soon.**"
- If the **TEMP** indicator flashes RED and the message below is displayed onscreen, please contact your local dealer or service center:
"**Fan fail. Lamp will automatically turn off soon.**"

Adjusting the Projected Image

Adjusting the Height of Projected Image

The projector is equipped with an elevator foot for adjusting the height of image.

To raise the image:

- 1 Turn the elevator foot to lengthen the foot.
- 2 Raise the image to the desired height angle.

To lower the image:

- 1 Turn the elevator foot to shorten the foot.
- 2 Lower the image to the desired height angle.

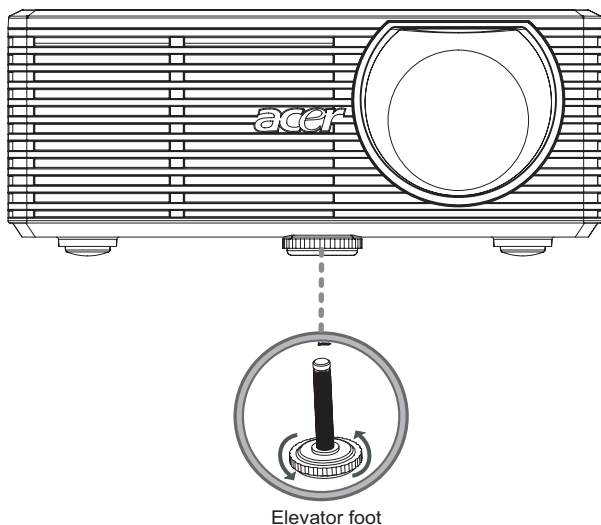

How to Optimize Image Size and Distance

Consult the table below to find the optimal image sizes achievable when the projector is positioned at a desired distance from the screen. Example: If the projector is 2.4m from the screen, good image quality is possible for image sizes 60".



Note: Remind as below figure, the space of 93 cm height is required when located at 2.4m distance.

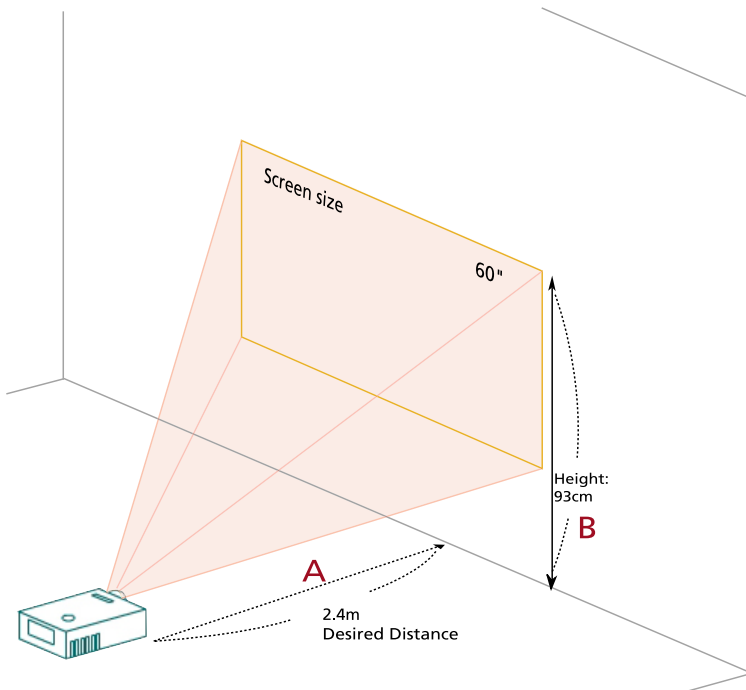

Figure: Fixed distance with optimal screen size.







Desired Distance (m) < A >	Screen Size		
	Diagonal (inch) < B >	W (cm) x H (cm)	From base to top of image (cm) < C >
0.6	15	30 x 23	26
1.2	30	61 x 46	49
2	50	102 x 76	79
2.4	60	122 x 91	93

User Controls

Onscreen Display (OSD) Menus

The Projector has multilingual OSD that allow you to make image adjustments and change a variety of settings. Be sure to connect power and input a signal before using the OSD menus.

Using the OSD menus

- To open the OSD menu, press "**MENU**" on the control panel.
- When the OSD is displayed, use the   keys to select any item in the main menu. After selecting the desired main menu item, press  to enter submenu for feature setting.
- Use the   keys to select the desired item and adjust the settings by using the   keys.
- Select the next item to be adjusted in the submenu and adjust as described above.
- Press "**MENU**" on the control panel, the screen will return to the main menu.
- To exit OSD, press "**MENU**" on the control panel again. The OSD menu will close and the projector will automatically save the new settings.

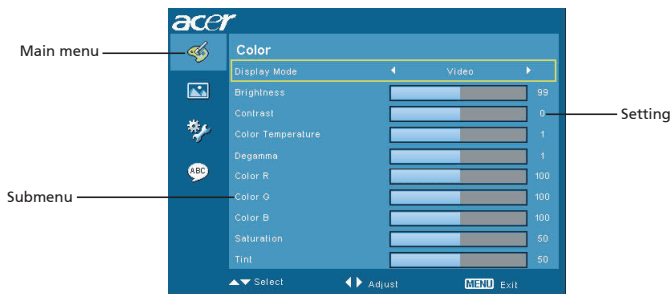

Color Setting

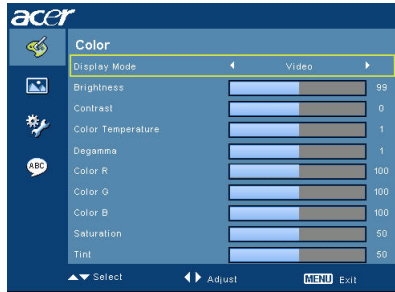

Display Mode	<p>There are many factory presets optimized for various types of images.</p> <ul style="list-style-type: none"> • Bright: For brightness optimization. • Standard: For true-color optimization. • Video: For playing video in a bright environment. • Blackboard: Blackboard mode can improve displayed color when you project onto darker surfaces. • User 1: Memorize user's settings. • User 2: Memorize user's settings.
Brightness	<p>Adjusts the brightness of the image.</p> <ul style="list-style-type: none"> • Press ◀ to darken image. • Press ▶ to lighten the image.
Contrast	<p>"Contrast" controls the difference between the lightest and darkest parts of the picture. Adjusting the contrast changes the amount of black and white in the image.</p> <ul style="list-style-type: none"> • Press ◀ to decrease the contrast. • Press ▶ to increase the contrast.
Color Temperature	<p>Adjusts the color temperature. At higher color temperatures, the screen looks colder; at lower color temperatures, the screen looks warmer.</p>
Degamma	<p>Effects the representation of dark scenery. With greater gamma value, dark scenery will look brighter.</p>
Color R	<p>Adjusts the red color.</p>
Color G	<p>Adjusts the green color.</p>
Color B	<p>Adjusts the blue color.</p>
Saturation	<p>Adjusts a video image from black and white to fully saturated color.</p> <ul style="list-style-type: none"> • Press ◀ to decrease the amount of color in the image. • Press ▶ to increase the amount of color in the image.





Tint	<p>Adjusts the color balance of red and green.</p> <ul style="list-style-type: none"> • Press ◀ to increase the amount of green in the image. • Press ▶ to increase the amount of red in the image.
------	---



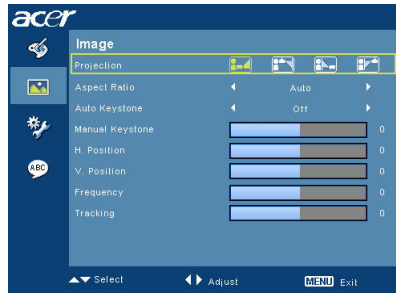



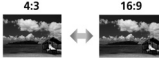

Note: "Saturation" and "Tint" functions are not supported under computer mode.

Image Setting



<p>Projection</p> 	<p>Front-Desktop</p> <ul style="list-style-type: none"> • The factory default setting.
	<p>Front-Ceiling</p> <ul style="list-style-type: none"> • When you select this function, the projector inverts the image for ceiling-mounted projection.
	<p>Rear-Desktop</p> <ul style="list-style-type: none"> • When you select this function, the projector reverses the image so you can project behind a translucent screen.
	<p>Rear-Ceiling</p> <ul style="list-style-type: none"> • When you select this function, the projector reverses and inverts the image at same time. You can project from behind a translucent screen with ceiling mounted projection.
<p>Aspect Ratio</p> 	<p>Use this function to choose your desired aspect ratio.</p> <ul style="list-style-type: none"> • Auto: Keep the image with original width-high ratio and maximize the image to fit native horizontal or vertical pixels. • 4:3: The image will be scaled to fit the screen and displayed using a 4:3 ratio. • 16:9: The image will be scaled to fit the width of the screen and the height adjusted to display image using a 16:9 ratio. • Full: Any types of resolution always fill the whole screen.

Auto Keystone	Choose "On" to enable auto keystone. Choose "Off" to disable auto keystone.
Manual Keystone	Adjusts image distortion caused by tilting projection. (± 40 degrees) 
H. Position (Horizontal Position)	<ul style="list-style-type: none"> Press  to move the image left. Press  to to move the image right.
V. Position (Vertical Position)	<ul style="list-style-type: none"> Press  to move the image down. Press  to move the image up.
Frequency	"Frequency" changes the projector's refresh rate to match the frequency of your computer's graphic card. If you can see a vertical flickering bar in the projected image, use this function to make an adjustment.
Tracking	Synchronizes the signal timing of the display with the graphic card. If you experience an unstable or flickering image, use this function to correct it.
Sharpness	Adjusts the sharpness of the image. <ul style="list-style-type: none"> Press  to decrease the sharpness. Press  to increase the sharpness.



Note: "H. Position", "V. Position", "Frequency" and "Tracking" functions are not supported under Video mode.

Note: "Sharpness" functions is not supported under Computer mode.

Management Setting

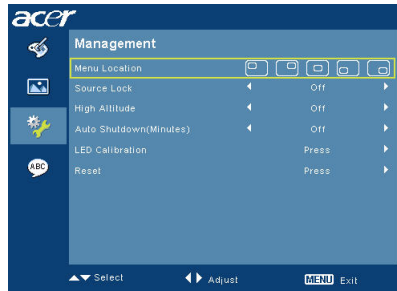

Menu Location	Choose the Menu location on the display screen
Source Lock	When source lock is turned "Off", the projector will search for other signals if the current input signal is lost. When source lock is turned "On", it will "Lock" the current source channel unless you press " SOURCE " button for next channel.
High Altitude	Use this function to allow the fans operates at full speed continuously to achieve proper high altitude cooling of the projector.
Auto Shutdown (Minutes)	The projector will auto shutdown while there is no signal input after the allocated time. (in minutes)
LED Calibration	<ul style="list-style-type: none"> Press after choosing "Yes", please wait for 10 seconds to finish the white color fine tune process. (This function can be used after 30 minutes turning on.) It helps to adjust LED color performance.
Reset	<ul style="list-style-type: none"> Press after choosing "Yes" to return the parameters on all menus to the factory default settings.

Language Setting



Language	<p>Choose the multilingual OSD menu . Use to select your preferred menu language.</p> <ul style="list-style-type: none"> Press to confirm the selection.
----------	--

Appendices

Troubleshooting

If you experience a problem with your Acer projector, refer to the following troubleshooting guide. If the problem persists, please contact your local reseller or service center.

Image Problems and Solutions

#	Problem	Solution
1	No image appears on screen	<ul style="list-style-type: none"> • Connected as described in the "Installation" section. • Ensure none of the connector pins are bent or broken.
2	Partial, scrolling or incorrectly displayed image (For PC (Windows 95/98/2000/XP))	<ul style="list-style-type: none"> • For an incorrectly displayed image: <ul style="list-style-type: none"> • Open "My Computer", open the "Control Panel", and then double-click the "Display" icon. • Select the "Settings" tab. • Verify that your display resolution setting is lower than or equal to SVGA (800 x 600). • Click the "Advanced Properties" button. • If the problem still appears, change the monitor display you are using and follow the steps below: <ul style="list-style-type: none"> • Verify that the resolution setting is lower than or equal to SVGA (800 x 600). • Click the "Change" button under the "Monitor" tab. • Click "Show all devices". Next, select "Standard monitor types" under the SP box, and choose the resolution mode you need under the "Models" box. • Verify that the resolution setting of the monitor display is lower than or equal to SVGA (800 x 600).
3	Partial, scrolling or incorrectly displayed image (For notebooks)	<ul style="list-style-type: none"> • For an incorrectly displayed image: <ul style="list-style-type: none"> • Follow the steps for item 2 (above) to adjust the resolution of your computer. • Press the respective button to toggle output settings. Example: [Fn]+[F4], Compaq [Fn]+[F4], Dell [Fn]+[F8], Gateway [Fn]+[F4], IBM [Fn]+[F7], HP [Fn]+[F4], NEC [Fn]+[F3], Toshiba [Fn]+[F5] • If you experience difficulty changing resolutions or your monitor freezes, restart all equipment including the projector.

4	The screen of the laptop computer is not displaying your presentation	<ul style="list-style-type: none"> • If you are using a Microsoft® Windows® based laptop: Some laptop PCs may deactivate their own screens when a second display device is in use. Each has a different way to be reactivated. Refer to your computer's manual for detailed information. • If you are using an Apple® Mac® OS based laptop: In System Preferences, open Display and select Video Mirroring "On".
5	Image is unstable or flickering	<ul style="list-style-type: none"> • Use "Tracking" to correct it. Refer to the "Image Setting" section for more information. • Change the display color depth settings on your computer.
6	Image has vertical flickering bar	<ul style="list-style-type: none"> • Use "Frequency" to make an adjustment. Refer to the "Image Setting" section for more information. • Check and reconfigure the display mode of your graphics card to make it compatible with the projector.
7	Image is out of focus	<ul style="list-style-type: none"> • Adjusts the focus ring on the projector lens. • Make sure the projection screen is within the required distance of 15 to 60 inches (0.38 to 1.52 meters) from the projector. Refer to the "How to Optimize Image Size and Distance" section for more information.
8	Image is stretched when displaying a "widescreen" DVD title	<p>When you play a DVD encoded in anamorphic or 16:9 aspect ratio you may need to adjust the following settings:</p> <ul style="list-style-type: none"> • If you play a 4:3 format DVD title, please change the format to 4:3 in the projector OSD. • If the image is still stretched, you will also need to adjust the aspect ratio. Set up the display format to 16:9 (wide) aspect ratio on your DVD player.
9	Image is too small or too large	<ul style="list-style-type: none"> • Move the projector closer to or further from the screen. • Press "MENU" on the control panel. Go to "Image setting --> Aspect Ratio" and try different settings.
10	Image has slanted sides	<ul style="list-style-type: none"> • If possible, reposition the projector so that it is centered on the screen. • Select "Image --> Auto Keystone --> On" on the OSD and correct a projected image with distortion.
11	Image is reversed	<ul style="list-style-type: none"> • Select "Image --> Projection" on the OSD and adjust the projection direction.
12	Image color abnormal	<ul style="list-style-type: none"> • Press "MENU" on the control panel. Select "Management --> Reset" function. • If it doesn't work, please activate "LED Calibration" in "Management" setting and wait for 10 seconds.

Problems with the Projector

#	Condition	Solution
1	The projector stops responding to all controls	If possible, turn off the projector, then unplug the power cord and wait at least 30 seconds before reconnecting power.

OSD Messages

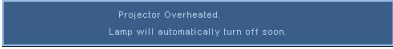
#	Condition	Message Reminder
1	Message	<p>Fan Fail - the system fan is not working.</p>  <p>Projector Overheated - the projector has exceeded its recommended operating temperature and must be allowed to cool down before it may be used.</p> 

LED & Alarm Definition Listing

LED Messages

Message	Lamp LED	Temp LED	Power LED	
	Red	Red	Red	Blue
Standby (AC adapter and power cord plugged in)	--	--	V	--
Turning on	--	--	--	V
Turning off (cooling state)	--	--	Quick flashing	--
Turning off (cooling completed)	--	--	V	--
Firmware download	V	V	V	--
Error (thermal switch or thermal sensor failure)	--	V	--	V
Error (fan lock failure)	--	Quick flashing	--	V

Specifications

The specifications below are subject to change without notice. For final specs, please refer to Acer's marketing documentation.

Projection system	DLP™
Resolution	SVGA (858 x 600)
Computer compatibility	IBM PC and compatibles, Apple Macintosh, iMac and VESA standards: SXGA, SVGA, VGA (resizing)
Video compatibility	NTSC (M/4.43), PAL (B/D/G/H/I/M/N), SECAM, HDTV (480i, 480p, 576i, 576p, 720p, 1080i)
Aspect ratio	4:3 (native), 16:9
Displayable colors	16.7 million colors
Projection lens	F / 2, f = 17.67 mm
Projection screen size (diagonal)	15" (0.38 m) - 60" (1.52 m)
Projection distance	1.97 feet (0.6 m) - 7.87 feet (2.4 m)
Throw ratio	1.97 (@4:3)
Horizontal scan rate	15 - 100 kHz
Vertical refresh scan rate	43 - 85 Hz
Keystone correction	+/- 40 degrees (manual) +/- 40 degrees (auto)
Weight	550 g (1.22 lbs.)
Dimensions (W x D x H)	126.9 x 121.6 x 48.7 mm (5.0 x 4.8 x 1.9 inches)
Power supply	+19V DC
Power consumption	<90 Watts <1 Watt at standby mode
Operating temperature	5°C to 35°C / 41°F to 95°F
I/O connectors	<ul style="list-style-type: none"> • DC IN x 1 • VGA input x 1 • Composite video x 1
Standard package contents	<ul style="list-style-type: none"> • AC adapter x 1 • AC power cord x 1 • VGA cable x 1 • Composite video cable x 1 • User's guide (CD-ROM) x 1 • Quick start guide x 1 • Carrying case x 1

* Design and specifications are subject to change without notice.

Compatibility Modes

A. VGA Analog

1 VGA Analog - PC Signal

Modes	Resolution	V.Frequency [Hz]	H.Frequency [KHz]
VGA	640x480	59.9	31.5
	640x480	72.8	37.9
	640x480	75	37.5
	640x480	85	43.3
SVGA	800x600	56.3	35.2
	800x600	60.3	37.9
	800x600	72.2	48.1
	800x600	75	46.9
	800x600	85.1	53.7
XGA	1024x768	60	48.4
	1024x768	70.1	56.5
	1024x768	75	60
	1024x768	85	68.7
SXGA	1152x864	75	67.5
	1280x960	60	60
	1280x1024	60	64
	1280x800	84.9	71.6
	1280x800	74.9	62.8
	1280x800	59.8	49.7

2 VGA Analog - HDTV Signal

Signal	V.Frequency [Hz]	H.Frequency [KHz]
480i	60	15.8
480p	60	31.5
576i	50	15.6
576p	50	31.3
720p	60	45
720p	50	37.5
1080i	60	33.8
1080i	50	28.1

Regulations and Safety Notices

FCC Notice

This device has been tested and found to comply with the limits for a Class B digital device pursuant to Part 15 of the FCC rules. These limits are designed to provide reasonable protection against harmful interference in a residential installation. This device generates, uses, and can radiate radio frequency energy and, if not installed and used in accordance with the instructions, may cause harmful interference to radio communications.

However, there is no guarantee that interference will not occur in a particular installation. If this device does cause harmful interference to radio or television reception, which can be determined by turning the device off and on, the user is encouraged to try to correct the interference by one or more of the following measures:

- Reorient or relocate the receiving antenna.
- Increase the separation between the device and receiver.
- Connect the device into an outlet on a circuit different from that to which the receiver is connected.
- Consult the dealer or an experienced radio/television technician for help.

Notice: Shielded cables

All connections to other computing devices must be made using shielded cables to maintain compliance with FCC regulations.

Notice: Peripheral devices

Only peripherals (input/output devices, terminals, printers, etc.) certified to comply with the Class B limits may be attached to this equipment. Operation with non-certified peripherals is likely to result in interference to radio and TV reception.

Caution

Changes or modifications not expressly approved by the manufacturer could void the user's authority, which is granted by the Federal Communications Commission, to operate this device.

Operation conditions

This device complies with Part 15 of the FCC Rules. Operation is subject to the following two conditions: (1) this device may not cause harmful interference, and (2) this device must accept any interference received, including interference that may cause undesired operation.

Notice: Canadian users

This Class B digital apparatus complies with Canadian ICES-003.

Remarque à l'intention des utilisateurs canadiens

Cet appareil numérique de la classe B est conforme à la norme NMB-003 du Canada.

Canada — Low-power license-exempt radio communication devices (RSS-210)

- a Common information
Operation is subject to the following two conditions:
 1. This device may not cause interference, and
 2. This device must accept any interference, including interference that may cause undesired operation of the device.
- b Operation in 2.4 GHz band
To prevent radio interference to the licensed service, this device is intended to be operated indoors and installation outdoors is subject to licensing.

Declaration of Conformity for EU countries

Acer hereby declares that this device is in compliance with the essential requirements and other relevant provisions of Directive 1999/5/EC.

Compliant with Russian regulatory certification



ME61

Radio device regulatory notice



.....
Note: Below regulatory information is for models with wireless LAN and/or Bluetooth only.

General

This product complies with the radio frequency and safety standards of any country or region in which it has been approved for wireless use. Depending on configurations, this product may or may not contain wireless radio devices (such as wireless LAN and/or Bluetooth modules). Below information is for products with such devices.

European Union (EU)

R&TTE Directive 1999/5/EC as attested by conformity with the following harmonized standard:

- Article 3.1(a) Health and Safety
 - EN60950-1:2001+ A11:2004
 - EN50371:2002
- Article 3.1(b) EMC
 - EN301 489-1 V1.6.1
 - EN301 489-3 V1.4.1 (Applicable to non-bluetooth wireless keyboard mouse set)
 - EN301 489-17 V1.2.1
- Article 3.2 Spectrum Usages
 - EN300 440-2 V1.1.2 (Applicable to non-bluetooth wireless keyboard mouse set)
 - EN300 328 V1.7.1
 - EN301 893 V1.4.1 (Applicable to 5GHz high performance RLAN)

List of applicable countries

EU member states as of May 2004 are: Belgium, Denmark, Germany, Greece, Spain, France, Ireland, Italy, Luxembourg, the Netherlands, Austria, Portugal, Finland, Sweden, United Kingdom Estonia, Latvia, Lithuania, Poland, Hungary, Czech Republic, Slovak Republic, Slovenia, Cyprus and Malta. Usage allowed in the countries of European Union, as well as Norway, Switzerland, Iceland and Liechtenstein. This device must be used in strict accordance with the regulations and constraints in the country of use. For further information, please contact a local office in the country of use.



Acer America Corporation
 333 West San Carlos St., San Jose
 CA 95110, U. S. A.
 Tel : 254-298-4000
 Fax : 254-298-4147
 www.acer.com



Federal Communications Commission Declaration of Conformity

This device complies with Part 15 of the FCC Rules. Operation is subject to the following two conditions: (1) this device may not cause harmful interference, and (2) this device must accept any interference received, including interference that may cause undesired operation.

The following local Manufacturer / Importer is responsible for this declaration:

Product:	DLP Projector
Model Number:	PSV0808
Machine Type:	K10
Name of Responsible Party:	Acer America Corporation
Address of Responsible Party:	333 West San Carlos St. San Jose, CA 95110 U. S. A.
Contact Person:	Acer Representative
Phone No.:	254-298-4000
Fax No.:	254-298-4147



Acer Incorporated
8F, 88, Sec. 1, Hsin Tai Wu Rd., Hsichih
Taipei Hsien 221, Taiwan

Declaration of Conformity

We,

Acer Incorporated

8F, 88, Sec. 1, Hsin Tai Wu Rd., Hsichih, Taipei Hsien 221, Taiwan

Contact Person: Mr. Easy Lai
Tel: 886-2-8691-3089 Fax: 886-2-8691-3120
E-mail: easy_lai@acer.com.tw

Hereby declare that:

Product: DLP Projector
Trade Name: Acer
Model Number: PSV0808
SKU Number: K10yyyyyy ("y" = 0~9, a ~ z, A ~ Z or Blank)

Is compliant with the essential requirements and other relevant provisions of the following EC directives, and that all the necessary steps have been taken and are in force to assure that production units of the same product will continue comply with the requirements.

EMC Directive 2004/108/EC as attested by conformity with the following harmonized standards:

- EN55022: 2006, AS/NZS CISPR22: 2006, Class B
- EN55024: 1998 + A1: 2001 + A2:2003
- EN61000-3-2: 2006, Class A
- EN61000-3-3: 1995 + A1: 2001+A2: 2005

Low Voltage Directive 2006/95/EC as attested by conformity with the following harmonized standard:

- EN60950-1: 2001 + A11: 2004

RoHS Directive 2002/95/EC on the Restriction of the Use of certain Hazardous Substances in Electrical and Electronic Equipment

The standards listed below are applied to the product if built with WLAN module or wireless keyboard and mouse.

R&TTE Directive 1999/5/EC as attested by conformity with the following harmonized standard:

● Article 3.1(a) Health and Safety

- EN60950-1:2001 + A11:2004
- EN50371:2002

● Article 3.1(b) EMC

- EN301 489-1 V1.6.1
- EN301 489-17 V1.2.1

● Article 3.2 Spectrum Usages

- EN300 328 V1.7.1
- EN301 893 V1.4.1 (Applicable to 5GHz high performance RLAN).

Year to begin affixing CE marking 2009.

Easy Lai
Easy Lai (Manager)
Regulation Center, Acer Inc.

Jan. 19, 2009 -
Date